

Device Features

- Output P1 dB = 25.2 dBm @ 1900 MHz
- Gain = 18.7 dB @ 1900 MHz
- LTE 20MHz ACLR = 15.1 dBm @ 1900 MHz
- RoHS2-compliant SOT-89 SMT package



Product Description

BeRex's BT09E is a high performance and a high dynamic range amplifier in a low cost surface mount package(SOT-89) with a RoHS2-compliant, that incorporates reliable heterojunction-bipolar-transistor (HBT) devices fabricated with InGaP/GaAs technology. This device is designed for use where high linearity is required and features high ACLR and P1 performance with low consumption current(85mA) and requires a few external matching components, such as DC blocking capacitors on the In/Output pin, a bypass capacitor on the Vcc pin, a bypass capacitor and a RF choke for the out port.

Applications

- Base station/Repeaters Infrastructure
- Commercial/Industrial/Military wireless system
- LTE / WCDMA /CDMA Wireless Infrastructure

Applications Circuit

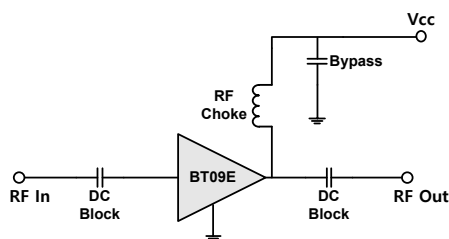

*External matching circuit:
Refer to application circuit for each frequency.

Electrical Specifications

Device performance _ measured on a BeRex evaluation board at 25°C, Vc=5V, 50 Ω system.

Parameter	Conditions	Min	Typ	Max	Unit
Operational Frequency Range		500		4000	MHz
Test Frequency			1900		MHz
Gain		17.2	18.7		dB
Input Return Loss			-18.0		dB
Output Return Loss			-13.0		dB
Output IP3 ¹	10 dBm/tone, Δf=1 MHz	34.0	37.0		dBm
Output P1dB		24.2	25.2		dBm
WCDMA ACLR*		14.2	15.2		dBm
LTE 20M ACLR*		14.1	15.1		dBm
Noise Figure			4.4		dB

¹Refer to application note for improved OIP3

*ACLR Channel Power measured at -50dBc.

- WCDMA set-up: 3GPP WCDMA, TM1+64DPCH, +5MHz offset, PAR 10.11 at 0.01% Prob.

- LTE set-up: 3GPP LTE, FDD E-TM1.1, 20MHz BW, ±20MHz offset, PAR 9.81 at 0.01% Prob.

Recommended Operating Conditions

Parameter	Min	Typ	Max	Unit
Bandwidth	500		4000	MHz
I _c @ (V _c = 5V)	68	85	102	mA
V _c	4.75	5.0	5.25	V
R _{TH}		38.5		°C/W
Operating Case Temperature	-40		+85	°C

Electrical specifications are measured at specified test conditions.

Specifications are not guaranteed over all recommended operating conditions.

Absolute Maximum Ratings

Parameter	Rating	Unit
Storage Temperature	-55 to +155	°C
Junction Temperature	+170	°C
Supply Voltage	+6	V
Supply Current	350	mA
Input RF Power	23	dBm

Operation of this device above any of these parameters may result in permanent damage.

Typical Performance (Vc=5V, Ic=85mA, T=25°C)

Parameter	Frequency					Unit
	900	1900	2140	2650	3500	MHz
Gain	22.8	18.7	17.7	16.1	13.7	dB
S11	-22.0	-18.0	-22.0	-17.0	-18.0	dB
S22	-8.5	-13.0	-14.0	-16.0	-18.0	dB
OIP3	40.5	37.0	37.0	36.5	36.5	dBm
P1dB	25.8	25.2	25.2	25.1	24.9	dBm
WCDMA ACLR	16.0	15.2	15.2	15.0	15.0	dBm
LTE 20M ACLR	15.2	15.1	15.1	14.9	14.5	dBm
Noise Figure	4.3	4.4	4.5	4.7	5.1	dB

V-I Characteristics

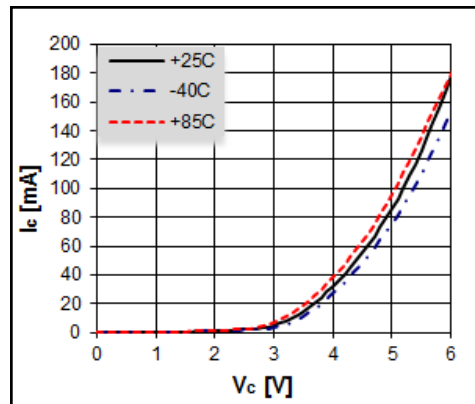

BeRex SOT89 Evaluation Board

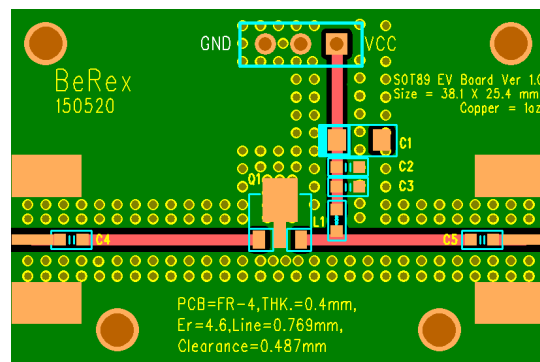

*Dielectric constant _ 4.6 *RF pattern width 0.769T *0.4T thick FR4 PCB

Typical Device Data

S-parameters ($V_c=5V$, $I_c=85mA$, $T=25^\circ C$)

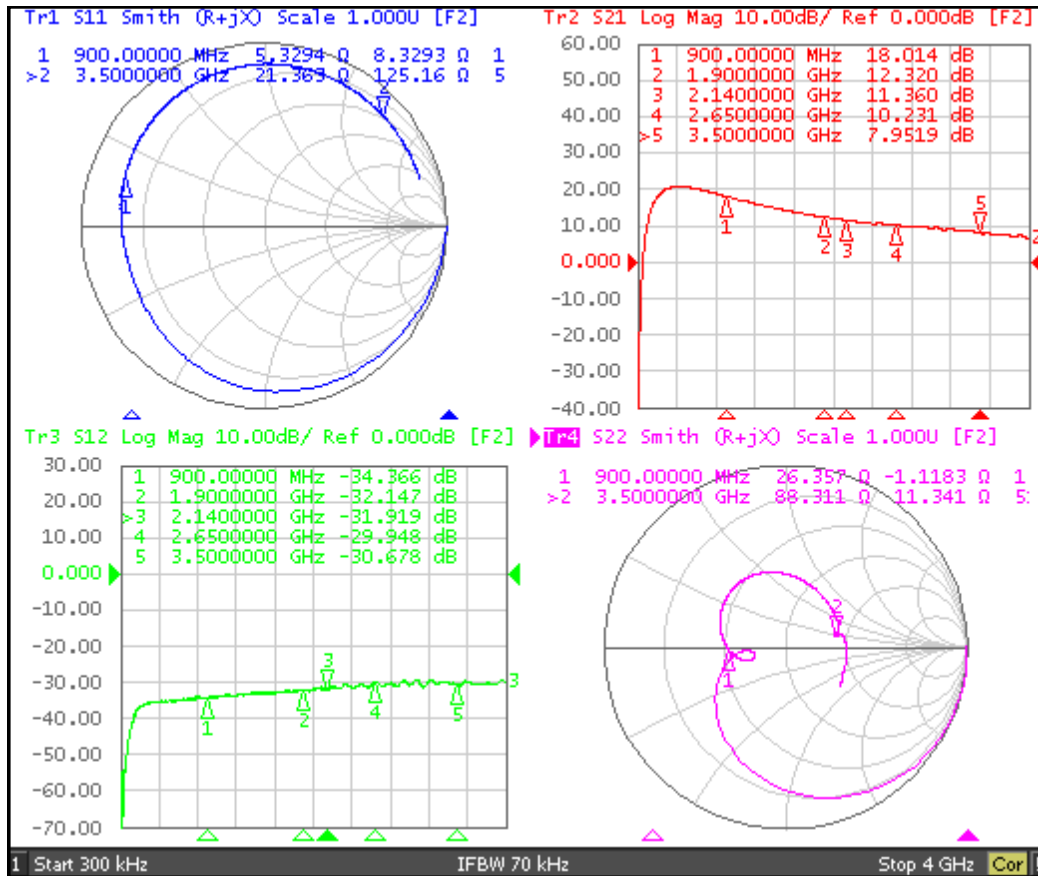

S-Parameter

($V_{device} = 5.0V$, $I_c = 85mA$, $T = 25^\circ C$, calibrated to device leads)

Freq [MHz]	S11	S11	S21	S21	S12	S12	S22	S22
	[Mag]	[Ang]	[Mag]	[Ang]	[Mag]	[Ang]	[Mag]	[Ang]
500	0.78	-165.83	10.72	165.44	0.02	32.39	0.17	-165.84
1000	0.82	154.35	7.39	103.86	0.02	19.54	0.34	175.61
1500	0.86	127.43	5.16	71.15	0.02	6.97	0.42	142.67
2000	0.88	105.69	3.93	46.76	0.02	1.62	0.43	116.92
2500	0.89	85.71	3.38	24.85	0.03	-13.41	0.41	91.24
3000	0.89	65.05	2.89	3.38	0.03	-26.14	0.35	57.89
3500	0.89	42.52	2.50	-23.26	0.03	-40.63	0.29	11.75
4000	0.90	17.02	2.13	-44.87	0.03	-57.64	0.37	-36.20

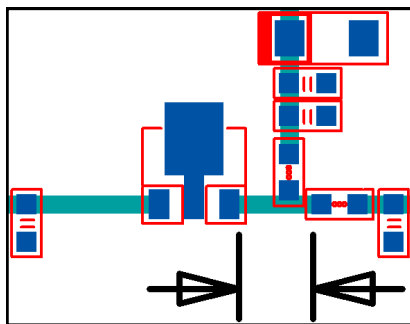
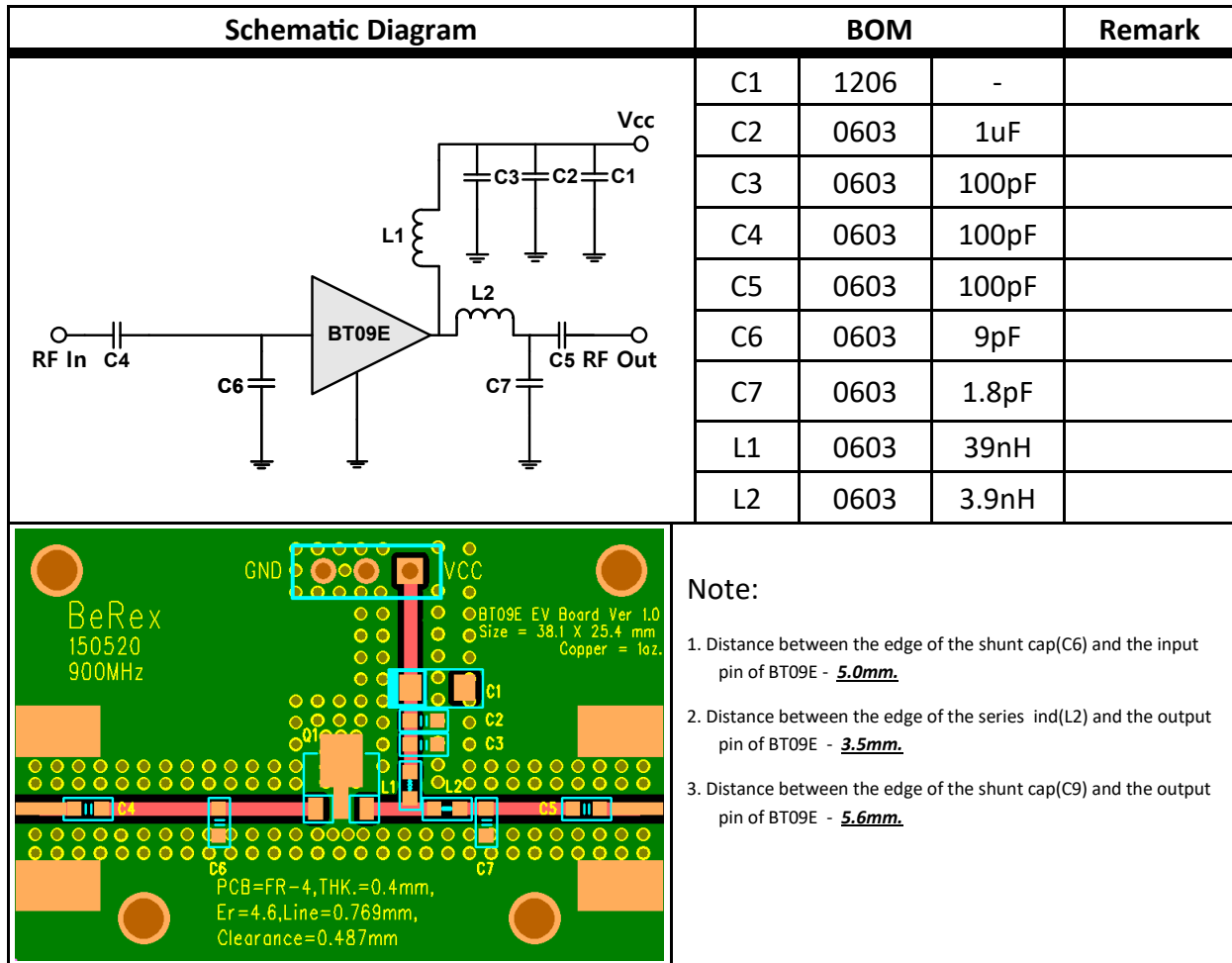
Application Circuit: 900 MHz

Figure about the reference position of components

Typical Performance

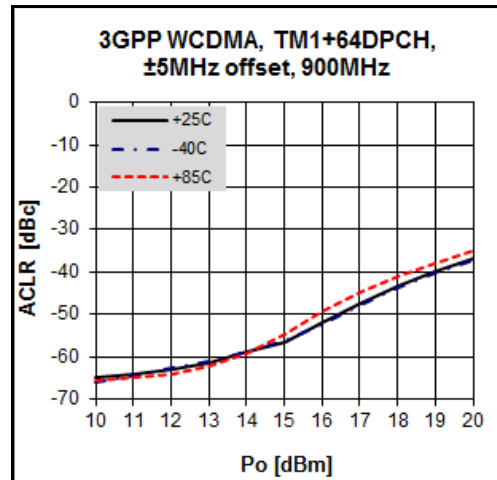
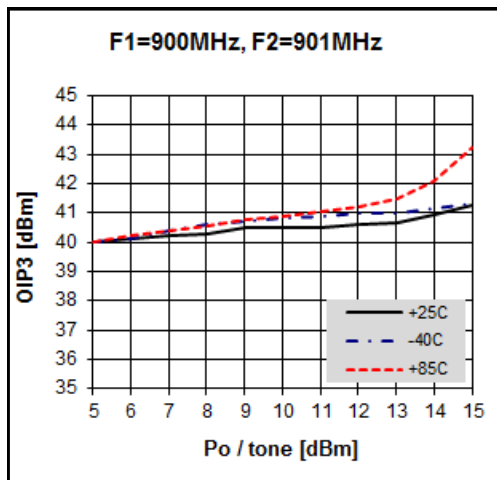
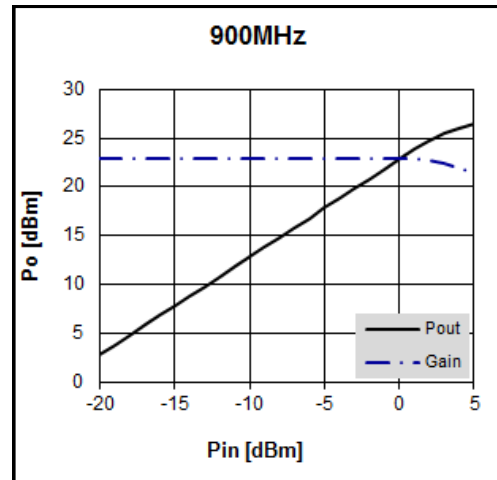
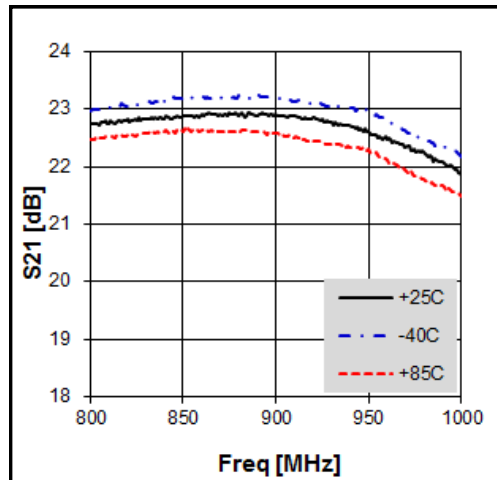
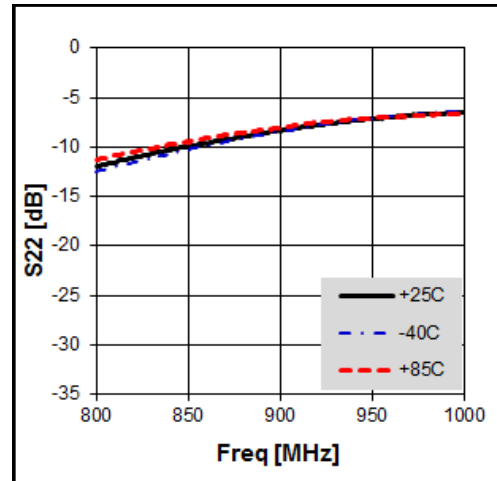
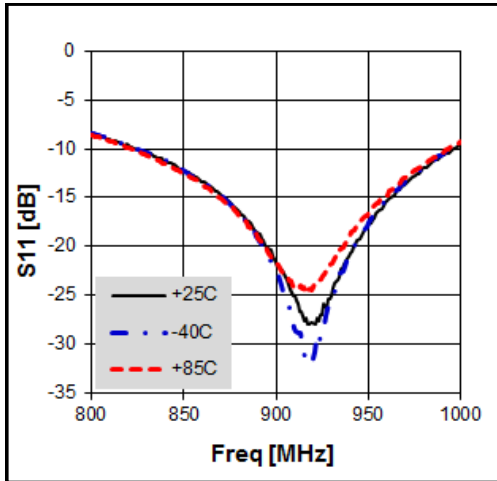
$V_c=5V, I_c=85mA, T=25^\circ C$

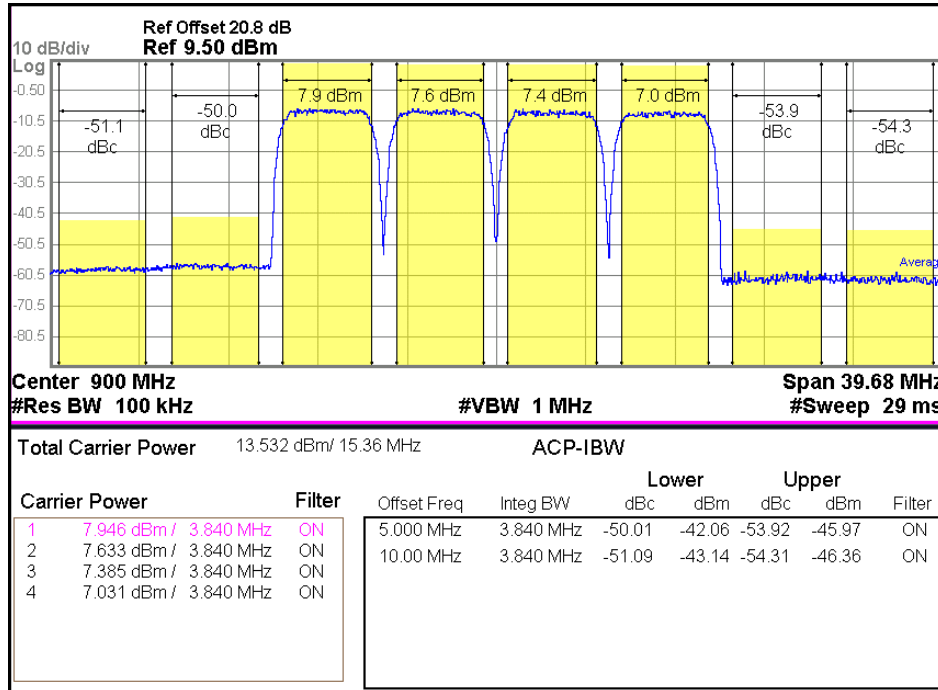

900MHz WCDMA 4FA ACLR (-50dBc)



900MHz LTE 20MHz ACLR (-50dBc)

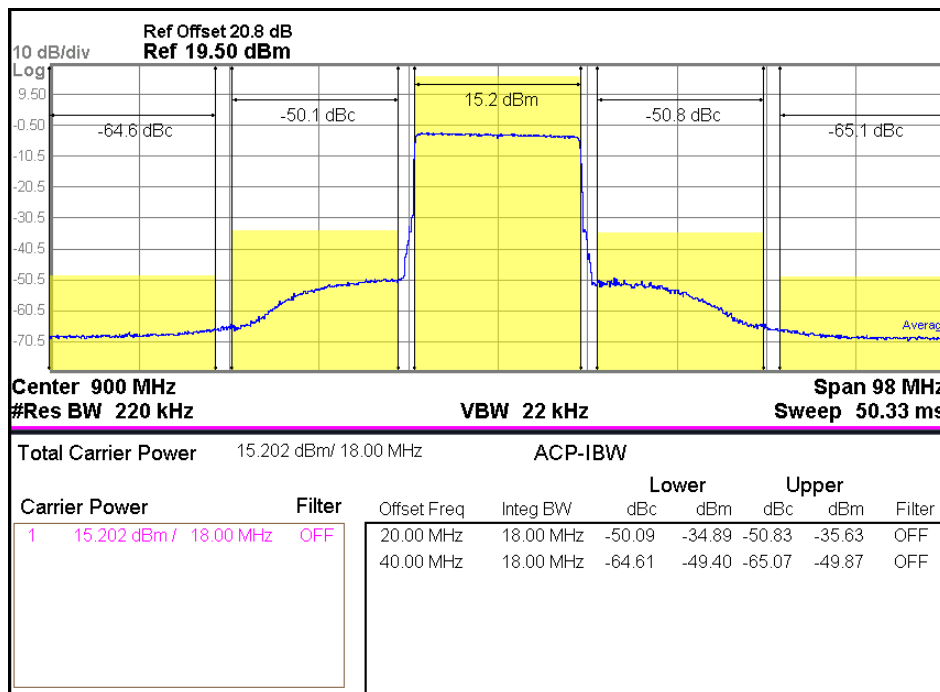

Application Circuit: 1900 MHz

Schematic Diagram	BOM			Remark
	C1	1206	-	
	C2	0603	1uF	
	C3	0603	62pF	
	C4	0603	0 Ω	jumper
	C5	0603	22pF	
	C6	0603	1.2pF	
	C7	0603	2.2pF	
	C8	0603	1pF	
	L1	0603	22nH	
	L2	0603	1.8nH	

PCB Layout	Note:
	<p>Note:</p> <ol style="list-style-type: none"> Distance between the edge of the series cap(C6) and the input pin of BT09E - <u>2.4mm.</u> Distance between the edge of the shunt cap(C7) and the input pin of BT09E - <u>1.2mm.</u> Distance between the edge of the series ind(L2) and the output pin of BT09E - <u>3.5mm.</u> Distance between the edge of the shunt cap(C9) and the output pin of BT09E - <u>5.6mm.</u>

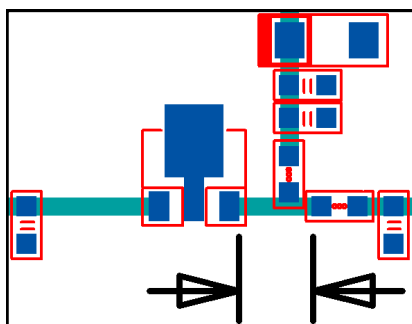
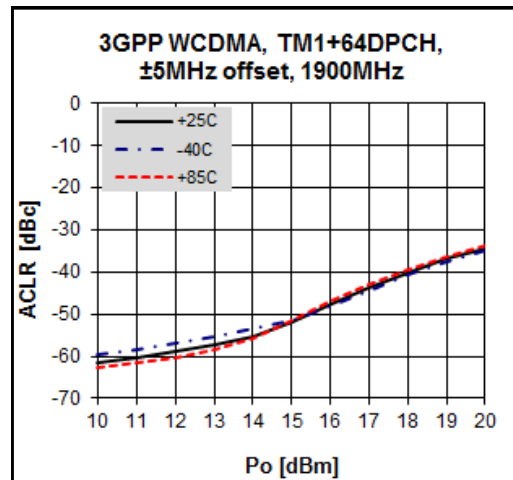
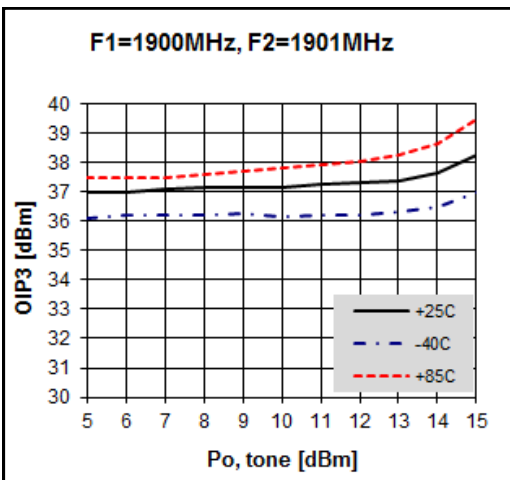
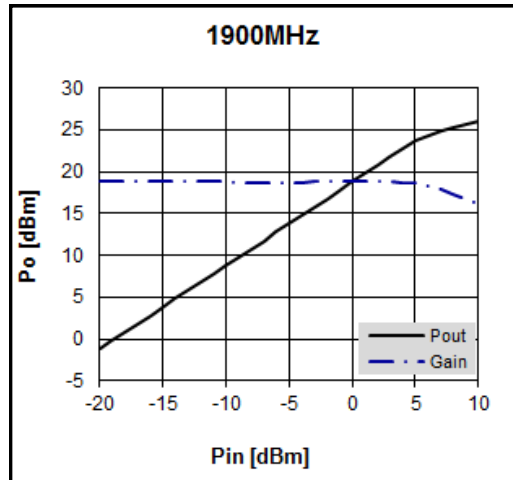
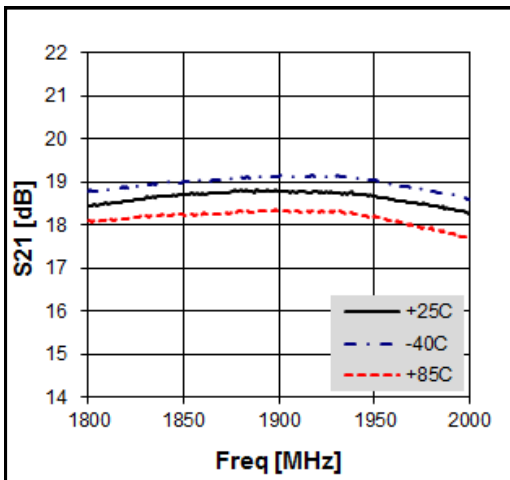
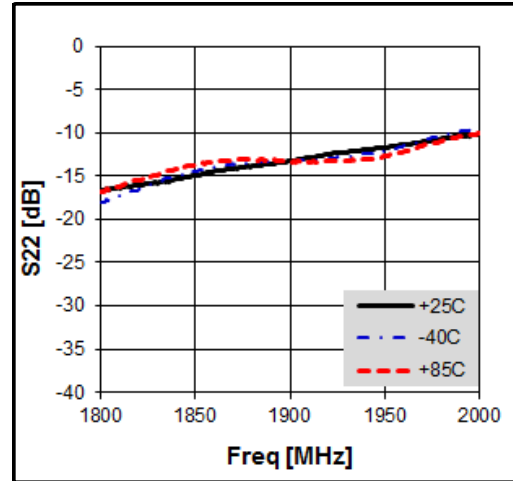
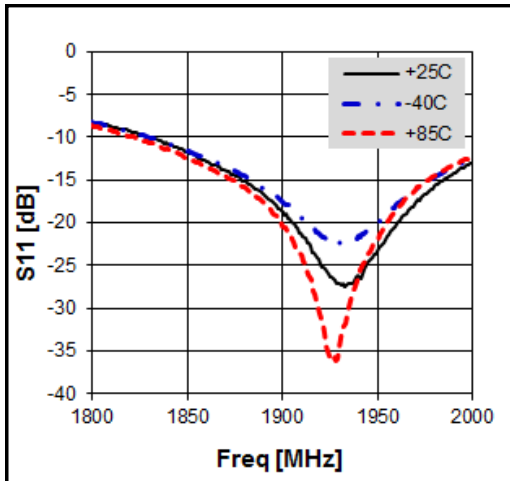

Figure about the reference position of components

Typical Performance

Vc=5V, Ic=85mA, T=25°C



1900MHz WCDMA 4FA ACLR (-50dBc)

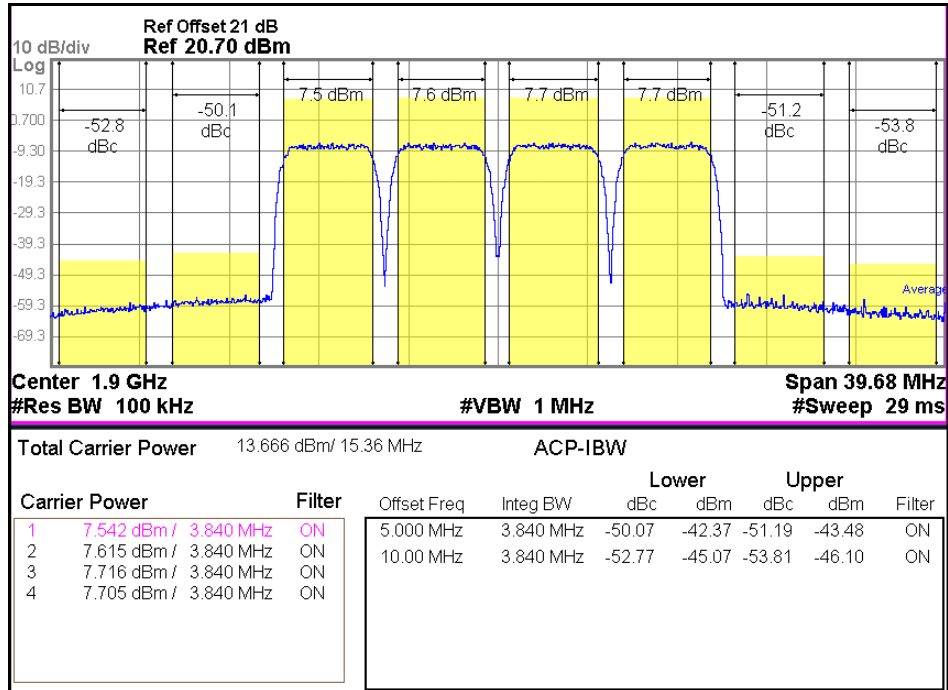

1900MHz LTE 20MHz ACLR (-50dBc)

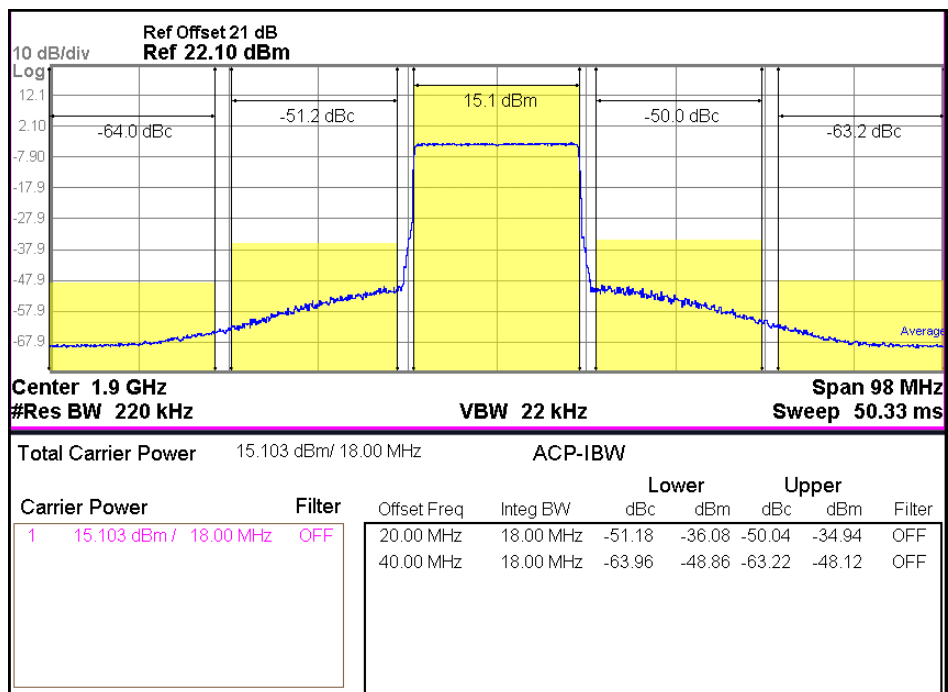

Application Circuit: 2140 MHz

Schematic Diagram	BOM			Remark
	C1	1206	-	
	C2	0603	1uF	
	C3	0603	62pF	
	C4	0603	0 Ω	jumper
	C5	0603	22pF	
	C6	0603	1pF	
	C7	0603	1.8pF	
	C8	0603	1pF	
	L1	0603	15nH	
	L2	0603	1.5nH	

PCB Layout	Note:
	<p>Note:</p> <ol style="list-style-type: none"> Distance between the edge of the series cap(C6) and the input pin of BT09E - <u>2.4mm.</u> Distance between the edge of the shunt cap(C7) and the input pin of BT09E - <u>0.5mm.</u> Distance between the edge of the series ind(L2) and the output pin of BT09E - <u>3.5mm.</u> Distance between the edge of the shunt cap(C9) and the output pin of BT09E - <u>5.6mm.</u>

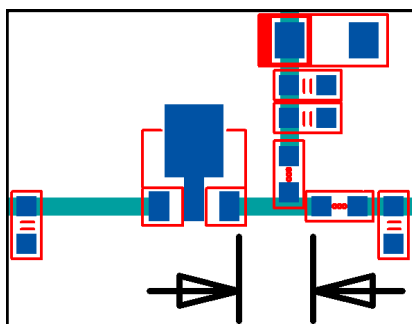
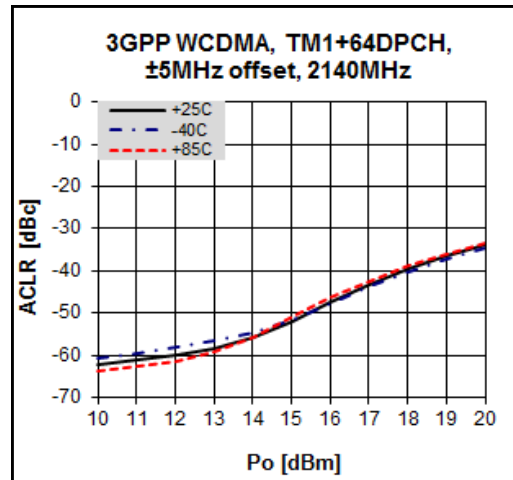
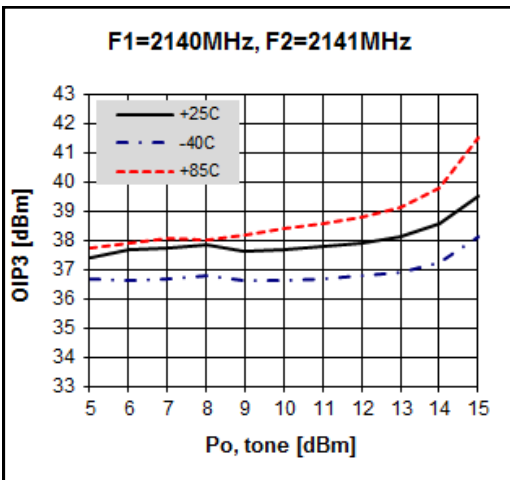
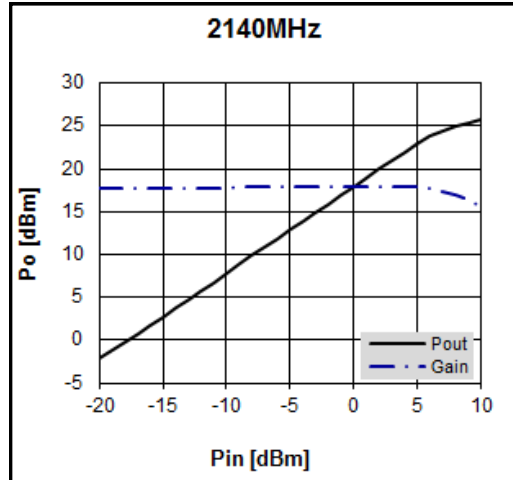
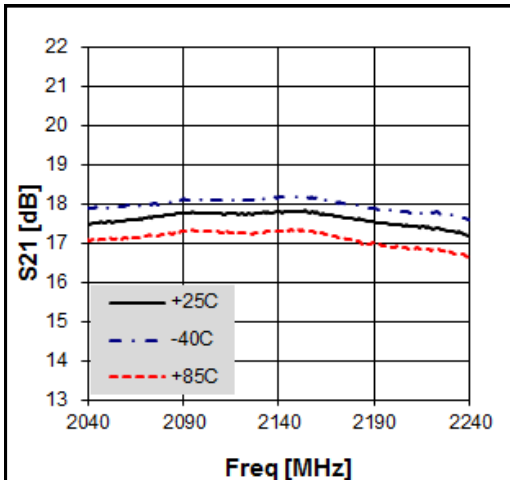
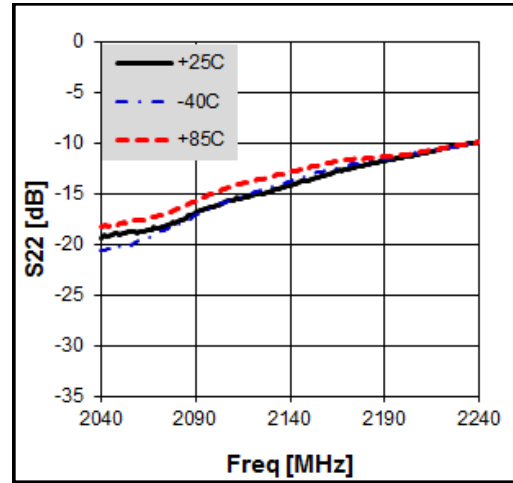
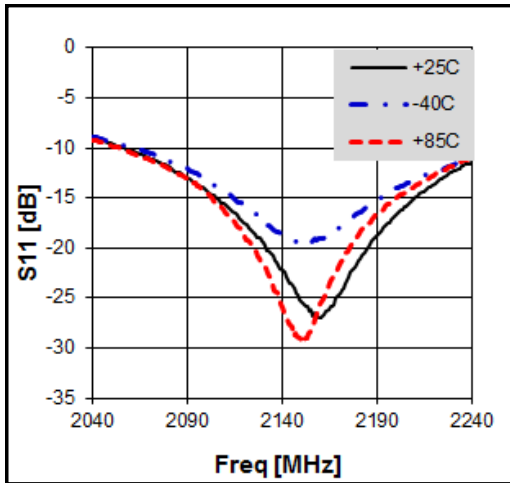

Figure about the reference position of components

Typical Performance

$V_c=5V, I_c=85mA, T=25^{\circ}C$



2140MHz WCDMA 4FA ACLR (-50dBc)

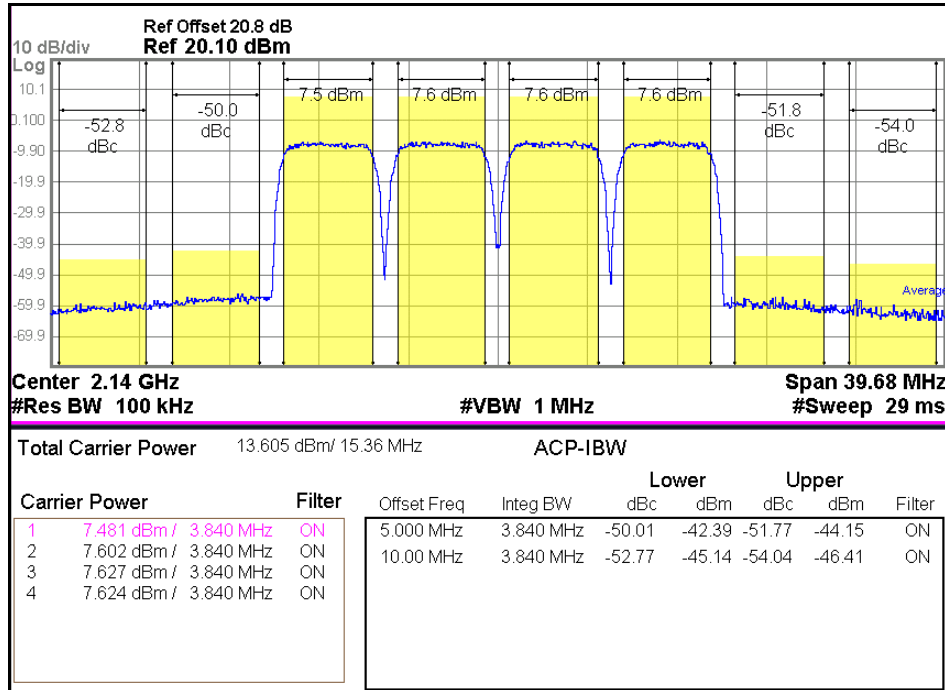

2140MHz LTE 20MHz ACLR (-50dBc)

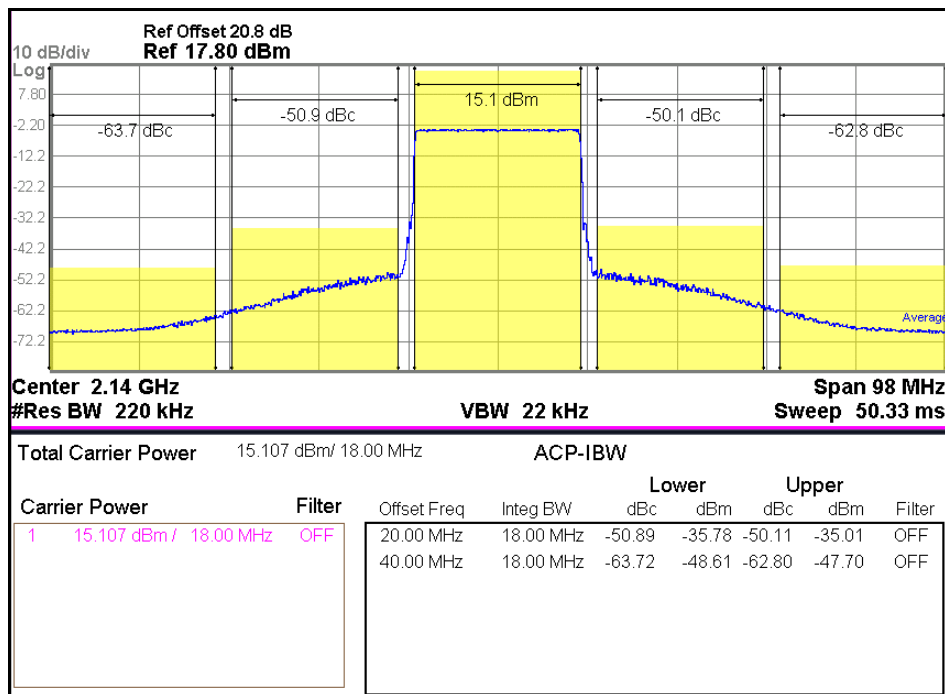

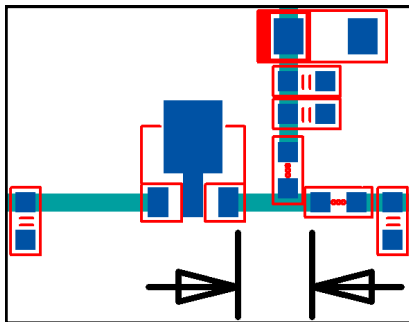
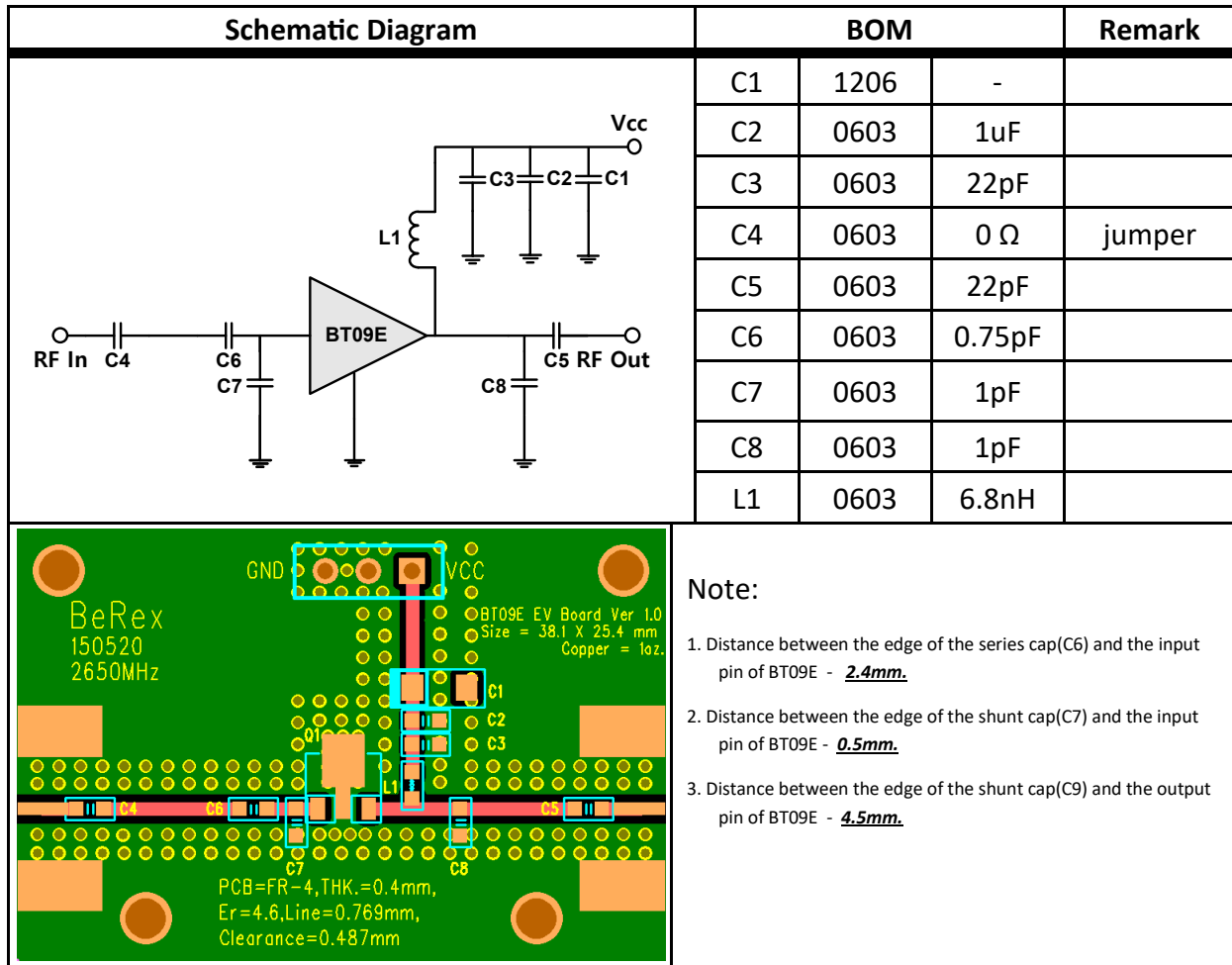
Application Circuit: 2650 MHz

Figure about the reference position of components

Typical Performance

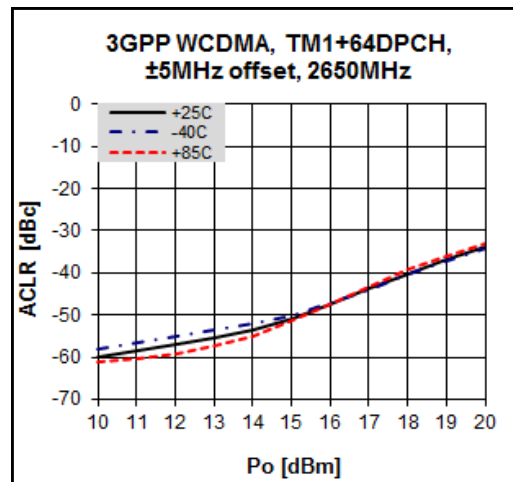
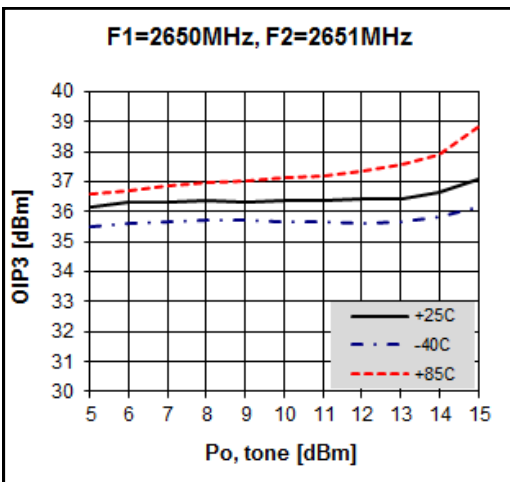
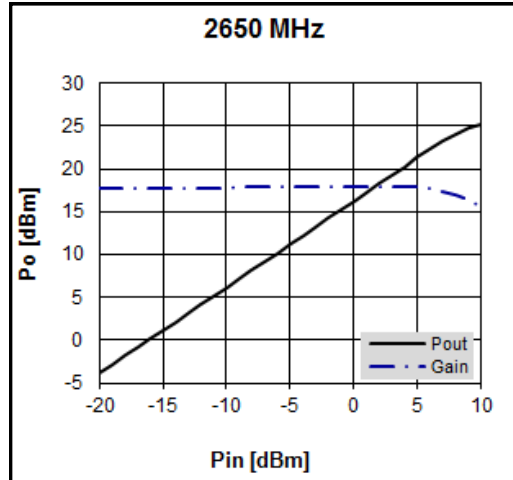
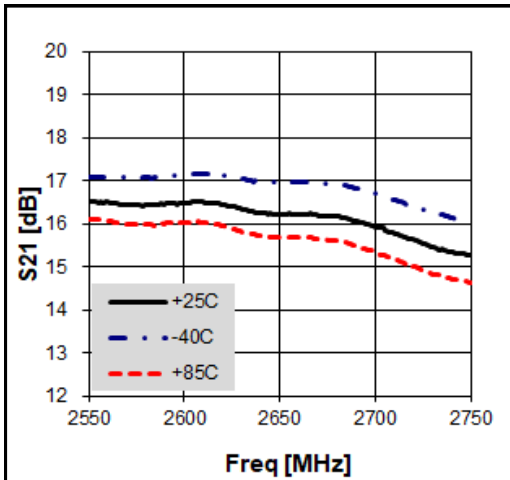
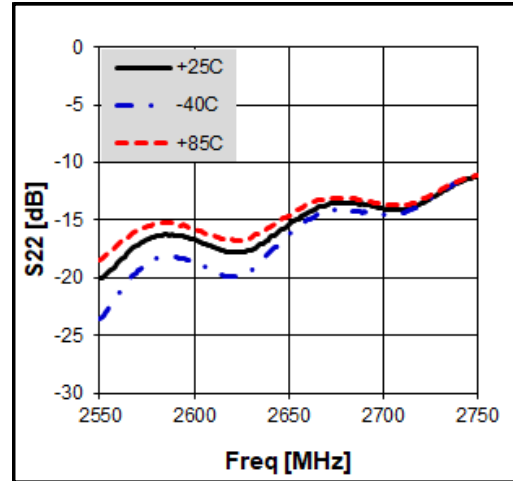
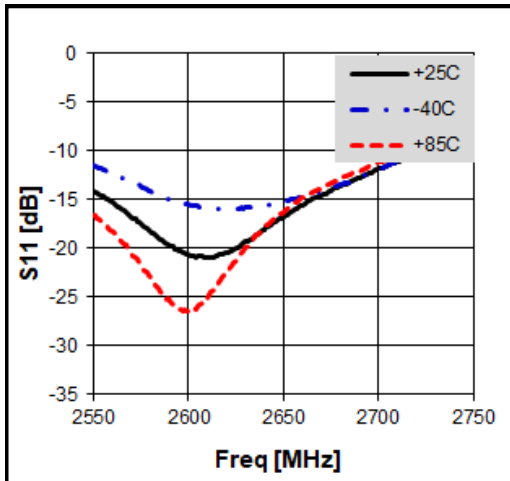
$V_c=5V, I_c=85mA, T=25^{\circ}C$

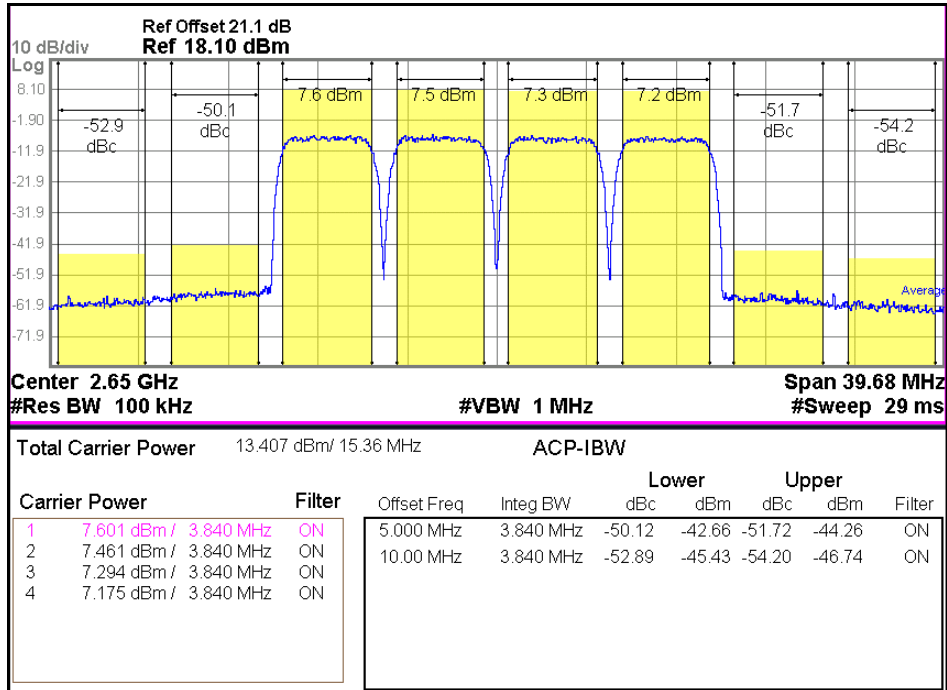
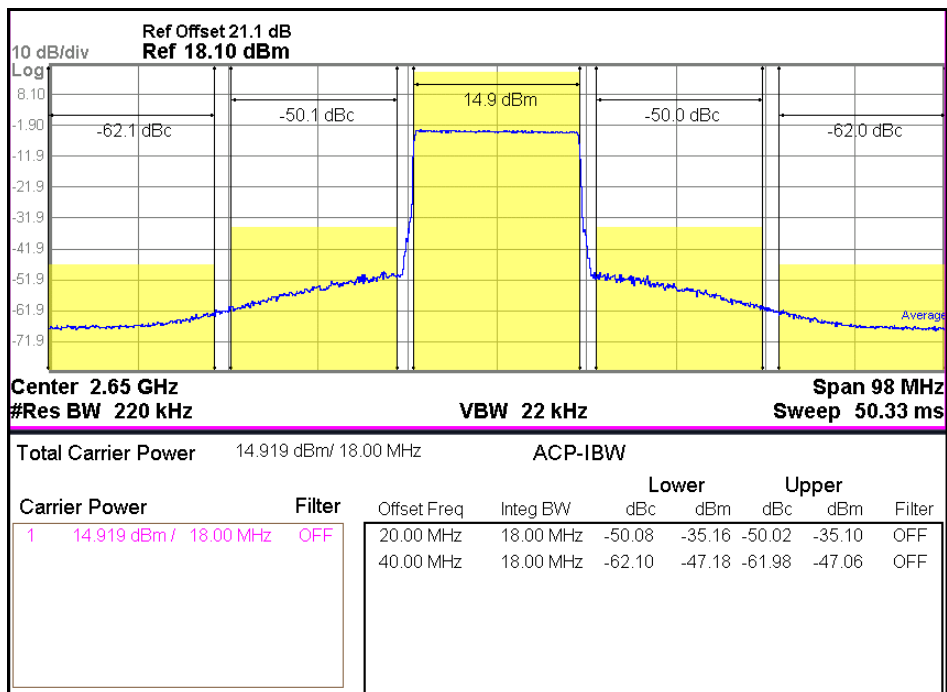

2650MHz WCDMA 4FA ACLR (-50dBc)

2650MHz LTE 20MHz ACLR (-50dBc)

Application Circuit: 3500 MHz

Schematic Diagram	BOM	Remark		
	C1	1206	-	
	C2	0603	1uF	
	C3	0603	22pF	
	C4	0603	0 Ω	jumper
	C5	0603	22pF	
	C6	0603	0.75pF	
	C7	0603	1pF	
	C8	0603	0.75pF	
L1	0603	6.8nH		

Note:
1. Distance between the edge of the series cap(C6) and the input pin of BT09E - <u>1.2mm</u> .
2. Distance between the edge of the shunt cap(C7) and the input pin of BT09E - <u>3.6mm</u> .
3. Distance between the edge of the shunt cap(C9) and the output pin of BT09E - <u>2.7mm</u> .

--

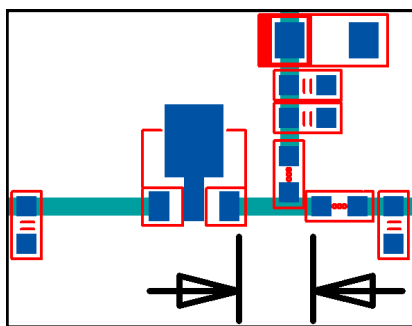
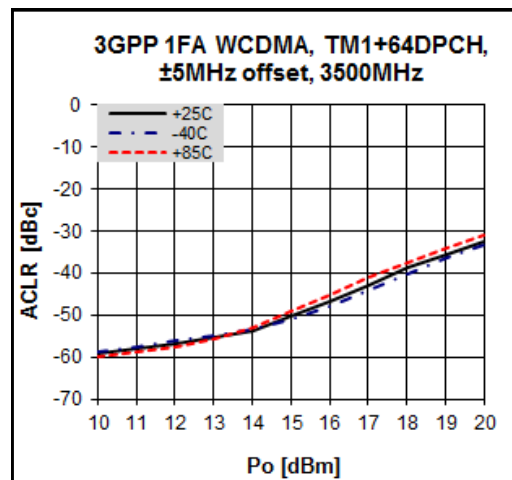
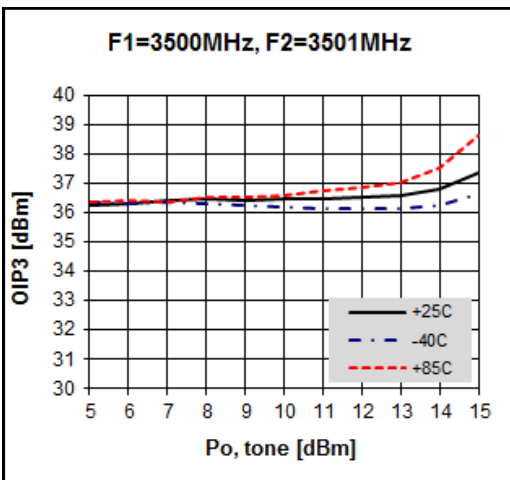
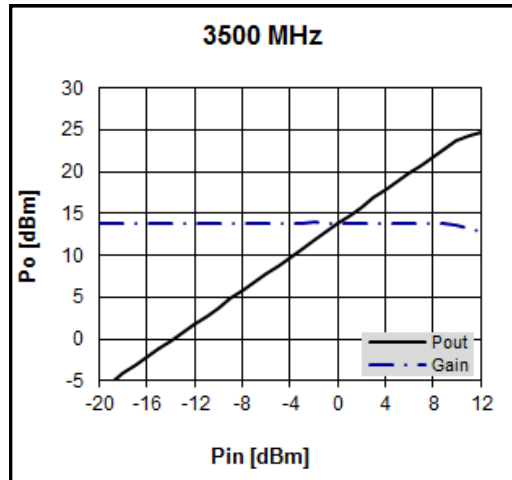
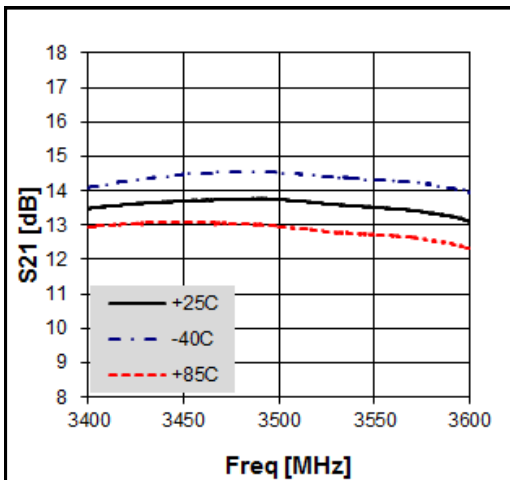
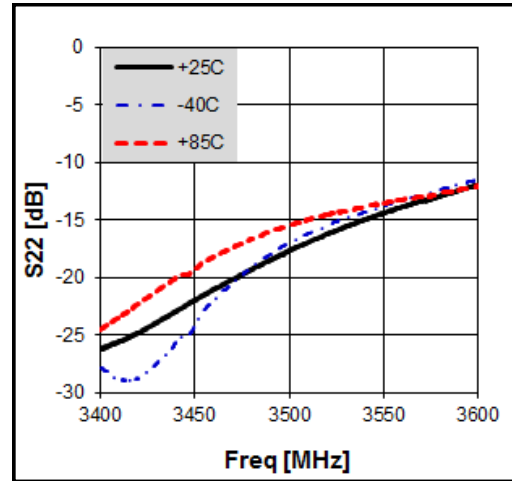
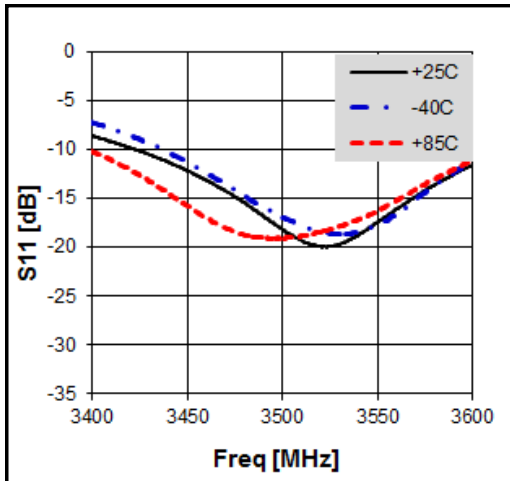

Figure about the reference position of components

Typical Performance

Vc=5V, Ic=85mA, T=25°C



3500MHz WCDMA 4FA ACLR (-50dBc)

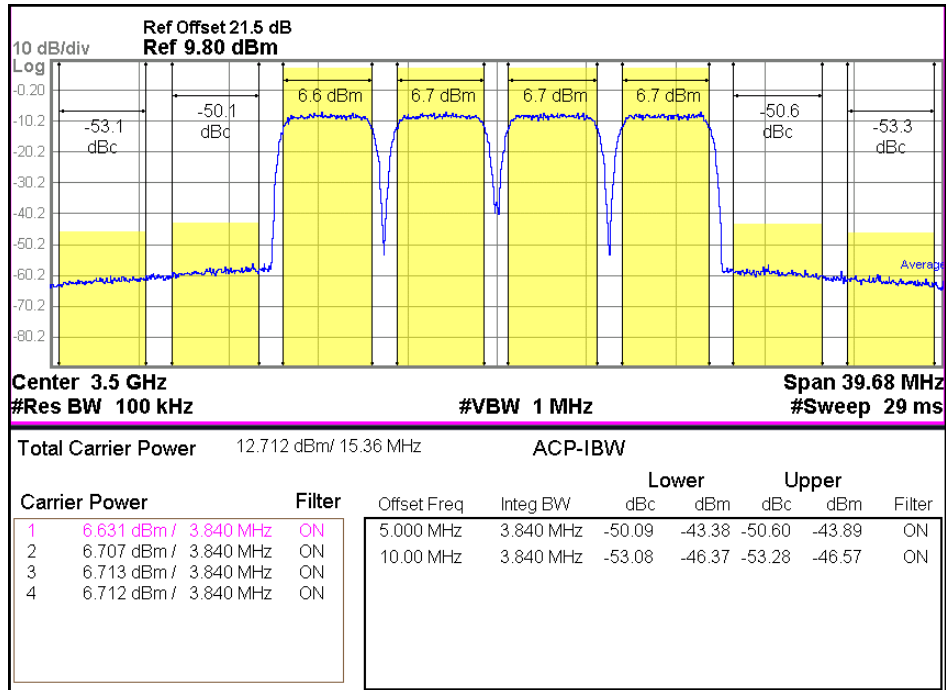

3500MHz LTE 20MHz ACLR (-50dBc)

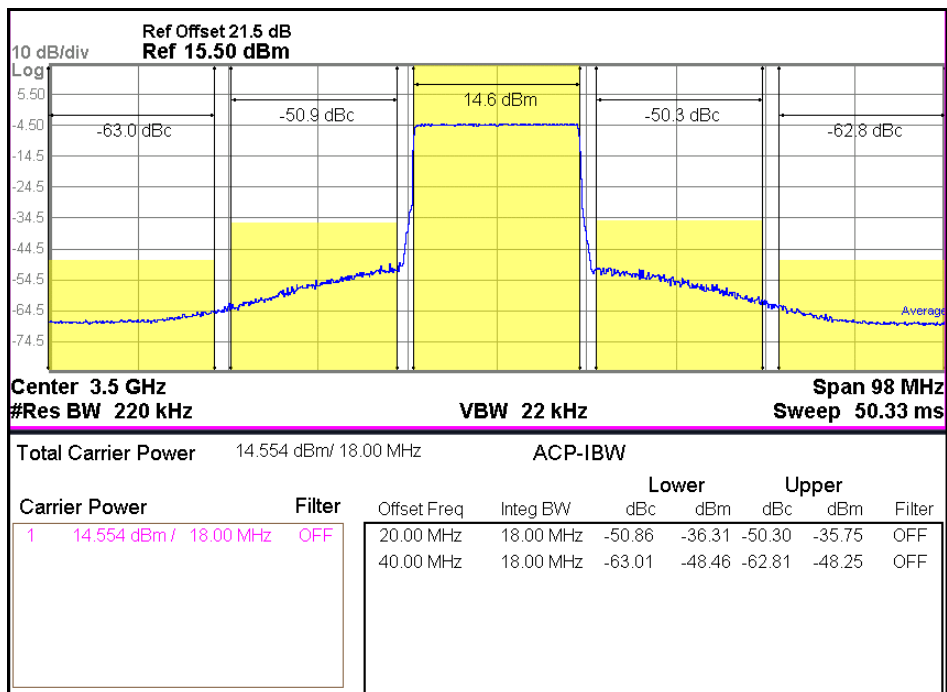

Package Outline Dimension

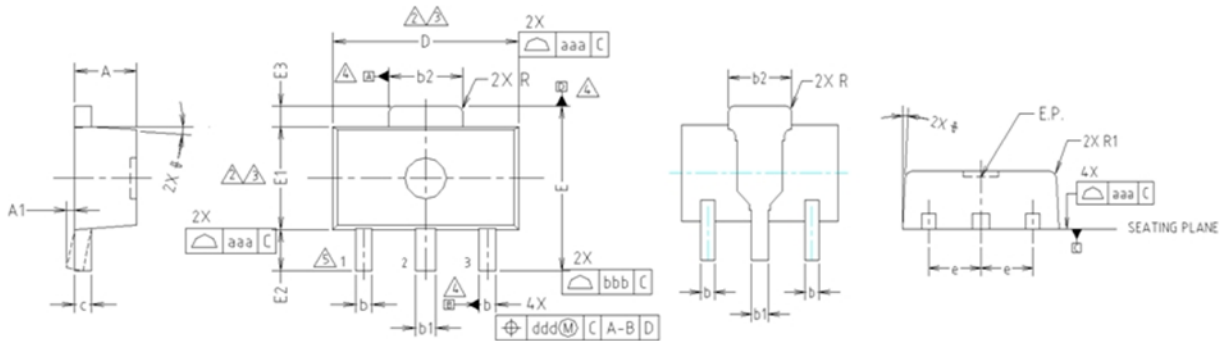

- NOTE:**
 1. DIMENSIONS IN MILLIMETERS.
- ⚠ DIMENSION D DOES NOT INCLUDE MOLD FLASH, PROTRUSIONS OR GATE BURRS. MOLD FLASH, PROTRUSIONS OR GATE BURRS SHALL NOT EXCEED 0.5mm PER END. DIMENSION E1 DOES NOT INCLUDE INTERLEAD FLASH OR PROTRUSION. INTERLEAD FLASH OR PROTRUSION SHALL NOT EXCEED 0.5mm PER SIDE.
 - ⚠ DIMENSIONS D AND E1 ARE DETERMINED AT THE OUTMOST EXTREMES OF THE PLASTIC BODY EXCLUSIVE OF MOLD FLASH, TIE BAR BURRS, GATE BURRS AND INTERLEAD FLASH, BUT INCLUDING ANY MISMATCH BETWEEN THE TOP AND BOTTOM OF THE PLASTIC BODY.
 - ⚠ DATUMS A, B AND D TO BE DETERMINED 0.18mm FROM THE LEAD TIP.
 - ⚠ TERMINAL NUMBERS ARE SHOWN FOR REFERENCE ONLY.

SYMBOL	MILLIMETERS			NOTE
	MINIMUM	NOMINAL	MAXIMUM	
A	1.40	1.50	1.60	
A1	0.00	—	0.10	
b	0.38	0.42	0.48	
b1	0.48	0.52	0.58	
b2	1.79	1.82	1.87	
c	0.40	0.42	0.46	
D	4.40	4.50	4.70	2,3
E	3.70	4.00	4.30	
E1	2.40	2.50	2.70	2,3
E2	0.80	1.00	1.20	
E3	0.40	0.50	0.60	
e	1.50 TYP.			
R	4° TYP.			
R1	0.15 TYP.			
			0.20	
SYMBOL	TOLERANCES OF FORM AND POSITION		NOTE	
aaa	0.15			
bbb	0.20			
ccc	0.10			
ddd	0.10			

PCB Land Pattern

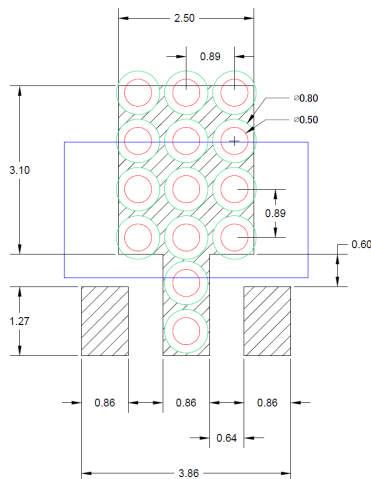

Note : All dimension _ millimeters

PCB lay out _ on BeRex website

PCB Mounting

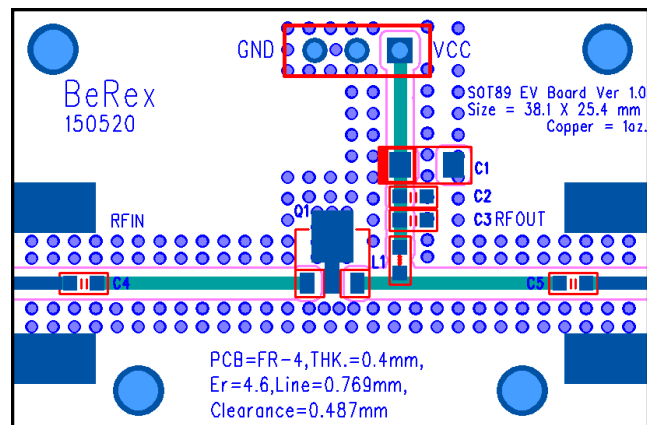

Package Marking

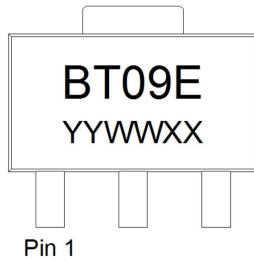

YY = Year, WW = Working Week,
XX = Wafer No.

Tape & Reel

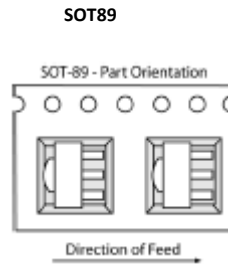

Packaging information:

Tape Width (mm): 12
Reel Size (inches): 7
Device Cavity Pitch (mm): 8
Devices Per Reel: 1000

Lead plating finish

100% Tin Matte finish

(All BeRex products undergoes a 1 hour, 150 degree C, Anneal bake to eliminate thin whisker growth concerns.)

MSL / ESD Rating

ESD Rating:	Class 1C
Value:	Passes <2000V
Test:	Human Body Model (HBM)
Standard:	JEDEC Standard JS-001-2012
MSL Rating:	Level 1 at +265°C convection reflow
Standard:	JEDEC Standard J-STD-020



Proper ESD procedures should be followed when handling this device.

NATO CAGE code:

2	N	9	6	F
---	---	---	---	---