



Surface Mounted Chip LED

Model No. : LS-SP150YG34-5

■ Features :

- Compatible with automatic placement equipment
- Compatible with reflow solder process

■ Applications :

- Automotive\_Telecommunication
- Indicators
- LCD Back-lights
- Illuminations

Dice Material	Light Color	Lens Color
GaP	Yellow Green	Water Clear

Absolute Maximum Ratings

( Ta=25°C )

Item	Symbol	Maximum	Unit
Power Dissipation	P <sub>D</sub>	78	mW
Continuous Forward Current	I <sub>F</sub>	30	mA
Peak Forward Current (1/10 Duty Cycle 0.1ms Pulse Width)	I <sub>FP</sub>	100	mA
Reverse Voltage	V <sub>R</sub>	5	V
Derating Linear From 25°C		0.4	mA/°C
Operating Temperature Range	T <sub>opr</sub>	-30 to +80	°C
Storage Temperature Range	T <sub>stg</sub>	-40 to +85	°C

Electrical / Optical Characteristics

( Ta=25°C )

Item	Symbol	Condition	Min.	Typ.	Max.	Unit
Forward Voltage	V <sub>F</sub>	IF=5mA		1.90	2.30	V
Reverse Current	I <sub>R</sub>	VR=5V			10	uA
Peak Emission Wavelength	λ <sub>P</sub>	IF=5mA		568		nm
Dominant Wavelength	λ <sub>D</sub>	IF=5mA		570		nm
Viewing Angle	2θ 1/2	IF=5mA		140		Deg
Luminous Intensity	I <sub>V</sub>	IF=5mA	1.0	3.0		mcd

ISSUE	DIMENSION NO :	VERSION :	DATE :
		A	2010/07/06
	APPROVAL :	CHECK :	EDIT :

◆ Packing coding principle

Notice: Bin code: luminous intensity / wavelength / voltage .

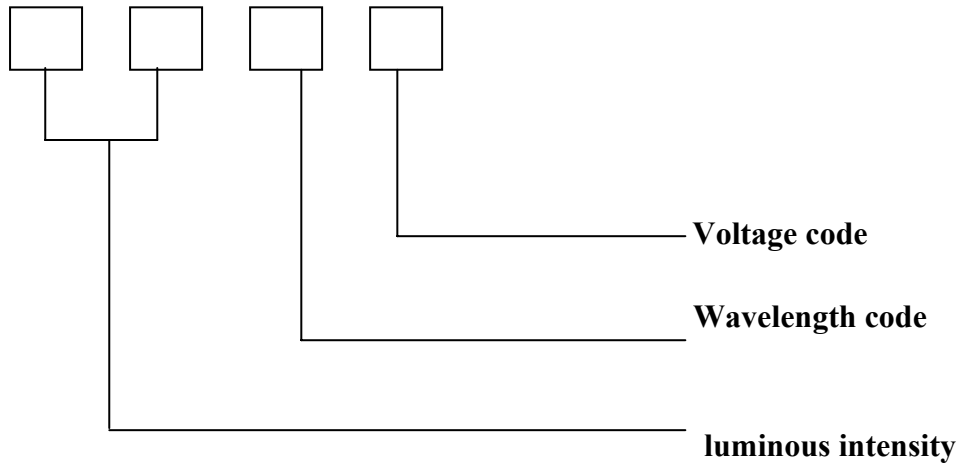

◆ The Luminous Intensity Grade of Yellow Green Chip-LED Products

● Test Condition : @ 5mA

Luminous Intensity (I <sub>v</sub> )	
Range,mcd	Bin code
1.0/2.2	C1
2.2/3.6	C2
3.6/5.1	D1

◆ Dominant Wavelength Grade of Yellow Green Chip-LED Products

● I type @ 5mA

BIN	Range
0	568/570
1	570/572
2	572/574
3	574/576

◆ Forward Voltage Grade of Yellow Green Chip-LED Products

● I type @ 5mA

BIN	Range	BIN	Range
5	1.9/2.0	7	2.1/2.2
6	2.0/2.1		



◆ **Descriptions :**

- The Chip-LED Taping is much smaller than lead frame type components, thus enable smaller board size, higher packing density, reduced storage space and finally smaller equipment to be obtained.
- Besides, lightweight makes them ideal for miniature application, etc.

◆ **Reliability Test Items And Conditions :**

NO.	Item	Test Conditions	Test Hours / Cycle	Sample Q'ty	Ac / Re
1	Solder Heat	TEMP : 260°C±5°C	5 sec	36 pcs	0 / 1
2	Temperature Cycle	H : +100°C 30min. ∩ 5min. L : -40°C 30min.	50 cycle	36 pcs	0 / 1
3	Thermal Shock	H : +100°C 5min. ∩ 10sec L : -40°C 5min.	50 cycle	36 pcs	0 / 1
4	High Temperature Storage	TEMP : 100°C	1000 hrs	36 pcs	0 / 1
5	Low Temperature Storage	TEMP : -40°C	1000 hrs	36 pcs	0 / 1
6	DC Operating Life	I <sub>F</sub> = 20mA	1000 hrs	36 pcs	0 / 1
7	High Temperature / High Humidity	85°C / 90~95%R.H.	1000 hrs	36 pcs	0 / 1

◆ **Reflow Temp. / Time :**

Please refer to the following figure :

Temp.(°C)		Time(Sec)	
a	25	T0~T1	Max. 3°C/sec
b	150	T1~T2	90~130 sec
c	200	T2~T3	Max. 3°C/sec
d	220	T3~T4	Max. 30~50 sec
e	250		
		T4~T5	Max. -3°C/sec
Blet Speed		70~90 cm/min	

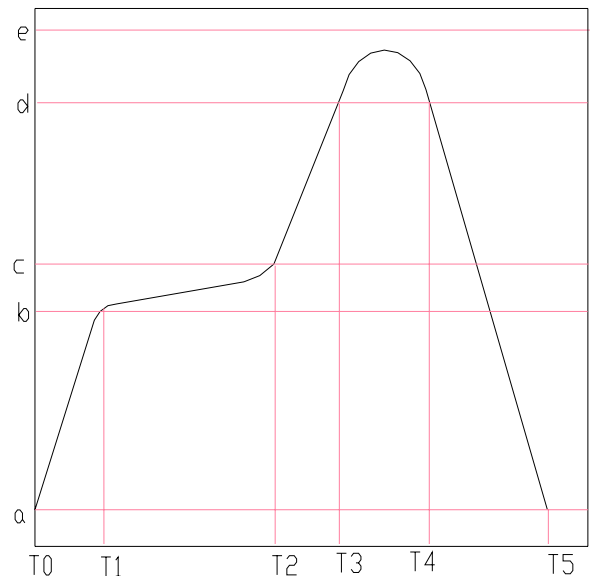

◆ **Precautions For Use :**

- Over - current - proof

Customer must apply resistors for protection, otherwise slight voltage shift will cause big current change ( Burn out will happen )

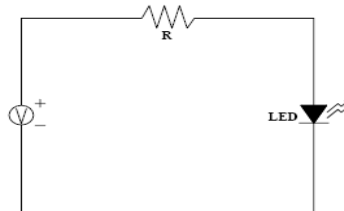

- Storage

1. The operation of temperature and R.H. are :  $5^{\circ}\text{C} \sim 30^{\circ}\text{C}$  , R.H.60% Max..
2. Once the package is opened, the products should be used within 72 hrs. Otherwise, they should be kept in a dampproof box with desiccating reagent. Considering the tape life, we suggest our customers to use our products within 1 year ( from production date ) .
3. It's recommended to bake before soldering when the package is unsealed after 72 hrs. The condition is :  $80^{\circ}\text{C} \pm 5^{\circ}\text{C}$  for 24hrs.

◆ **Soldering Iron :**

- Temperature at tip of iron :  $300^{\circ}\text{C}$  Max. ( 25W Max. )
- Soldering time :  $5 \pm 1\text{sec}$ .

◆ **Wave Soldering Temp. / Time :**

Temp.( $^{\circ}\text{C}$ )		Time(Sec)	
a	25	T1~T2	$60 \pm 20$
b	$130 \pm 10$	T2~T3	
c	185	T3~T6	
d	$250 \pm 3$	T4~T5	$3 \pm 2$

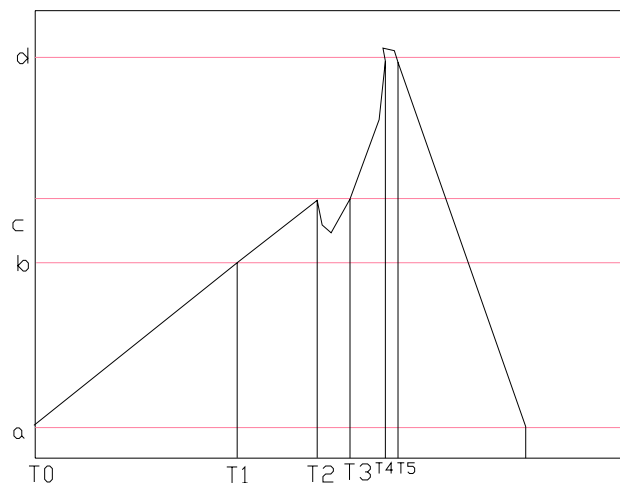



◆ Package Dimensions of Device ( LS-SP150 Series )

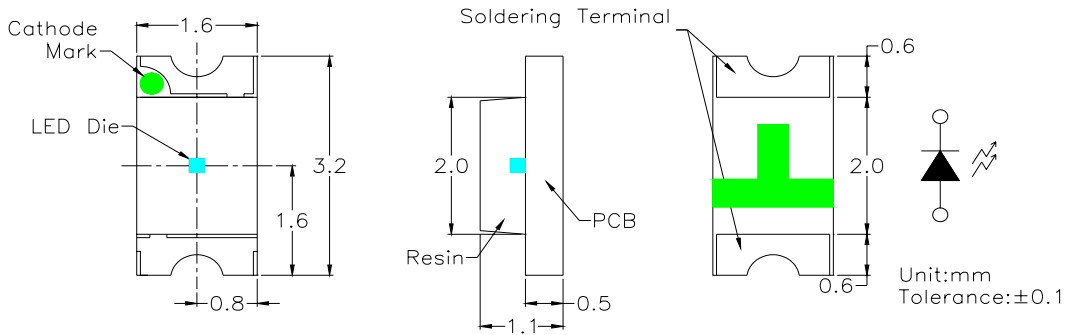

◆ Recommended Soldering Pad Dimensions

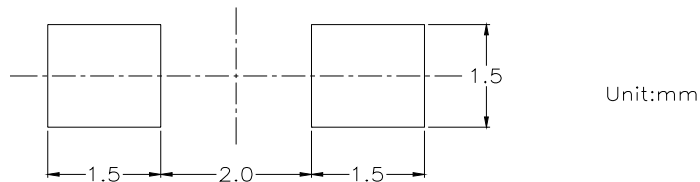

◆ Tape Specification : 3000pcs Per Reel

Packing Size													
Item	W	P1	E	F	Do	D1	Po	10Po	P2	Ao	Bo	Ko	t
Spec.	8.00	4.00	1.75	3.50	1.50	1.00	4.00	40.00	2.00	1.85	3.45	1.27	0.22
Tolerance	±0.20	±0.10	±0.10	±0.05	<sup>+0.10</sup> <sub>-0.00</sub>	±0.05	±0.05	±0.20	±0.05	±0.10	±0.10	±0.10	±0.05

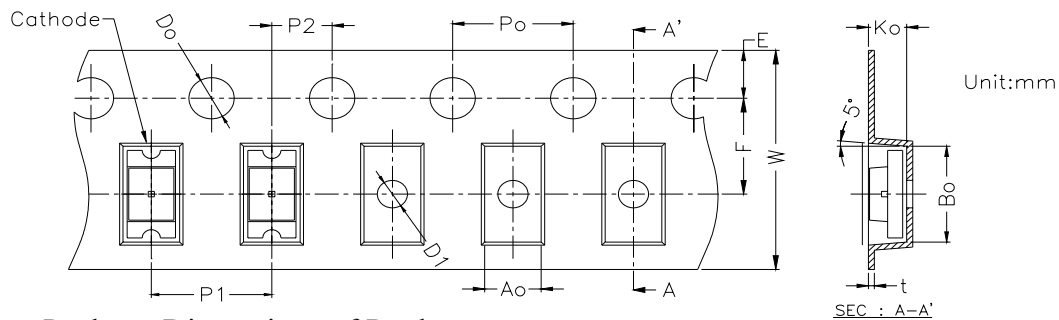

◆ Package Dimensions of Reel :

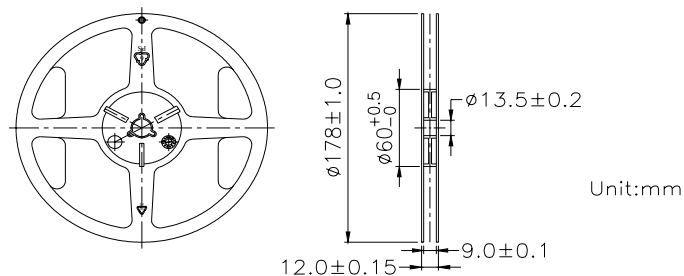

Forward Current Vs. Forward Voltage

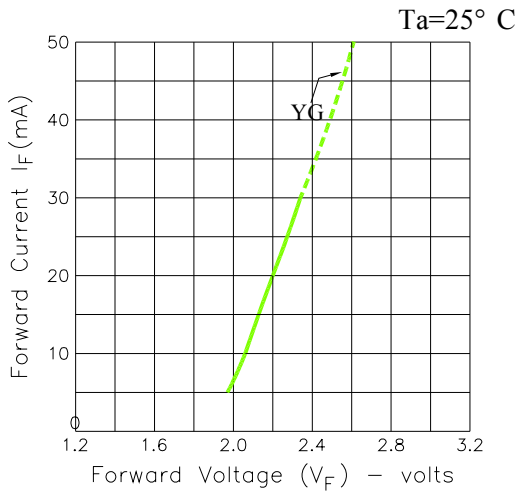

Luminous Intensity Vs. Forward Current

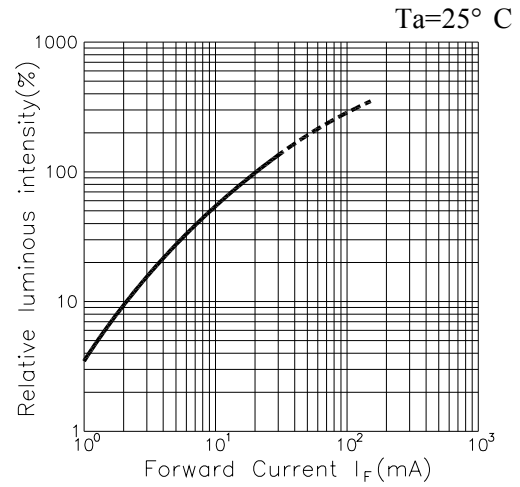

Forward Current Derating Curve

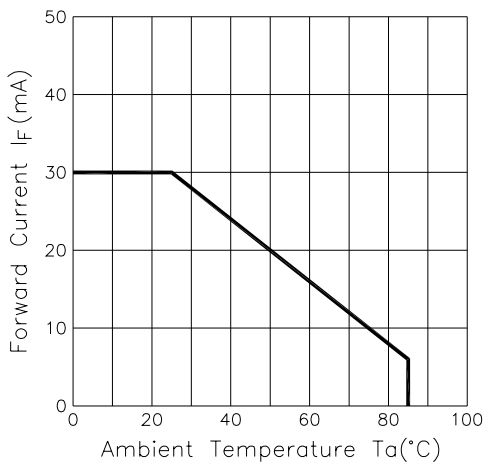

Radiation Diagram

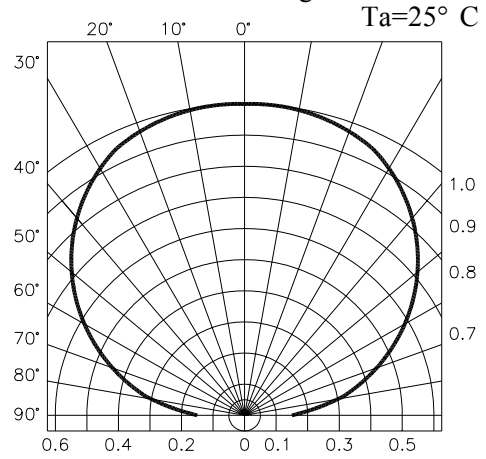

Spectrum Distribution

